

ONE GOAL, ONE DREAM - MISSION SELECTION 2024

PREMIUM BUNDLE PDF COURSE 2024

Highlighting Segments

- Beginners Bundle Quiz Course
- Topic-Wise Bundle Course
- Exam-Wise Bundle PDF Course
- Section-Wise Bundle PDF Course
- Memory Based Questions Bundle Course
- Prelims Scoring Part Bundle Course
- Mains Booster Bundle Course
- Critical Reasoning Bundle Course
- Mains Two Mark Questions Bundle Course
- Daily Editorial Based English Questions PDF
- Special Quants Arithmetic Bundle Course
- Special DI & Caselet Bundle Course
- Special Puzzles & Seating Bundle Course
- 101 Version 2.0 New Pattern Puzzles & DI Questions
- Current Affairs Bundle PDF Course
- Static Banking & Static GK Bundle Course
- Computer Awareness Bundle Course

***Special Offer For PRIME Users**

One Time Offer Ends Soon - Hurry!!!

GRAB IT NOW

Linear Seating Arrangement for Bank Exam – Question Bank Set 2 (Eng)

Directions (1-5): Study the following information carefully and answer the below questions

Nine persons- L, M, N, O, P, Q, R, S and T are sitting in a linear row facing towards the south, but not necessarily in the same order.

R sits third from the left end. Only one person sits between R and N. Only three persons sit between N and O who does not sit to the left of N. Only one person sits between O and L. M sits immediate right of Q. S sits second to the right of T. S sits adjacent to neither R nor N. As many persons sit between Q and T is same as between S and P.

1) What is the position of P with respect to O?

- a) immediate left
- b) Fourth to the right
- c) Fourth to the left
- d) Third to the left
- e) Third to the right

2) Which of the following statement(s) is/are true with respect to the final arrangement?

- a) M sits second to the right of O
- b) P sits at the end of the row
- c) No one sits between Q and S
- d) R sits third to the left of S
- e) All the statement is true

3) Who among the following person sits fourth to the left of S?

- a) The one who sits immediate right of N
- b) The one who sits second to the left of L

- c) M
- d) Q
- e) R

4) Who among the following person does not sit to the left of O?

- a) The one who sits fourth to the left of L
- b) T
- c) P
- d) The one who sits second to the right of T
- e) N

5) If R and N are interchanged their positions in the same way T and P are interchanged their positions, then how many persons sit between P and S?

- a) Five
- b) Four
- c) Three
- d) Two
- e) One

Directions (6-10): Study the following information carefully and answer the below questions.

Nine persons- I, J, K, L, M, N, O, P and Q are sitting in a linear row facing south, but not necessarily in the same order. The consecutive alphabetically named persons are not sitting together.

Only two persons sit between I and M who sits third from one of the extreme ends. As many persons sit to the left of M as to the right of O. N

Linear Seating Arrangement for Bank Exam – Question Bank Set 2 (Eng)

sits second to the right of O. J sits third to the right of K. As many persons sit between M and Q as between K and P.

6) How many persons sit between I and M?

- A. One
- B. Five
- C. Four
- D. Two
- E. Three

7) Which of the following statement is true?

- A. L sits second to the left of P
- B. No one sits between N and O
- C. M sits immediate right of I
- D. Only three persons sit between J and P
- E. All the statement is true

8) If all the persons are arranged in alphabetical order from the right end (as per the south direction), then how many persons remain unchanged in their position?

- A. One
- B. Two
- C. Three
- D. More than three
- E. None

9) Who among the following person sits at the right end of the row?

- A. K
- B. L
- C. The one who sits immediate left of M
- D. The one who sits immediate right of J
- E. O

10) If I and M interchange in their positions, then how many persons sit to the left of I?

- A. Five
- B. Four
- C. Three
- D. Two
- E. One

ANSWER WITH EXPLANATION

Directions (1-5):

- 1) Answer: D
- 2) Answer: D
- 3) Answer: A
- 4) Answer: D
- 5) Answer: E

Final Arrangement

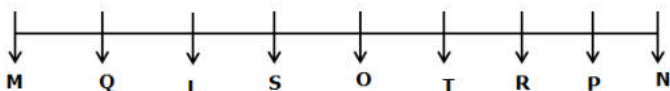

We have,

- R sits third from the left end.
- Only one person sits between R and N.
- Only three persons sit between N and O who does not sit to the left of N.

From the above conditions, there are two possibilities.

Linear Seating Arrangement for Bank Exam – Question Bank Set 2 (Eng)

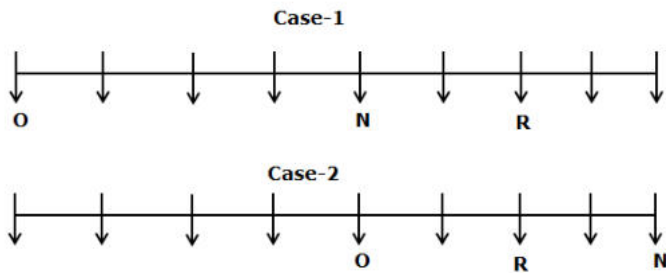

Again we have,

- Only one person sits between O and L.
- M sits immediate right of Q.
- S sits second to the right of T.
- S sits adjacent to neither R nor N.
- As many persons sit between Q and T is same as between S and P.

From the above conditions, Case-1 gets eliminated. Case-2 shows the final arrangement.

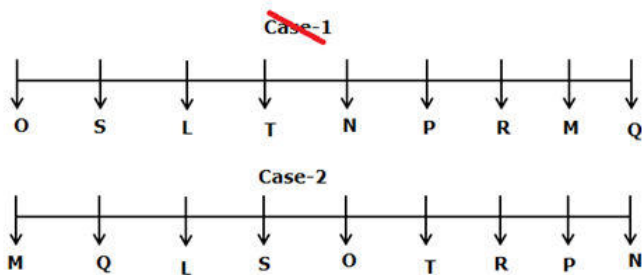

Directions (6-10):

- 6) Answer: D
- 7) Answer: D
- 8) Answer: A
- 9) Answer: D
- 10) Answer: D

Final arrangement

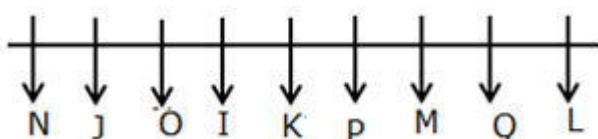

We have,

- Only two persons sit between I and M who sits third from one of the extreme ends.
- As many persons sit to the left of M as to the right of O.
- N sits second to the right of O.

From the above condition, there are two possibilities.

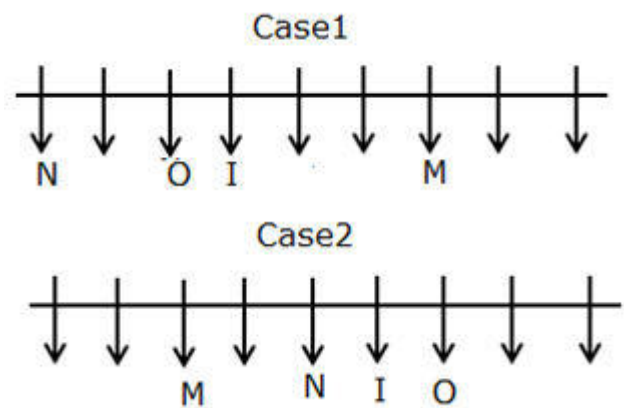

Again we have,

- J sits third to the right of K.

From the above condition, there are three possibilities.

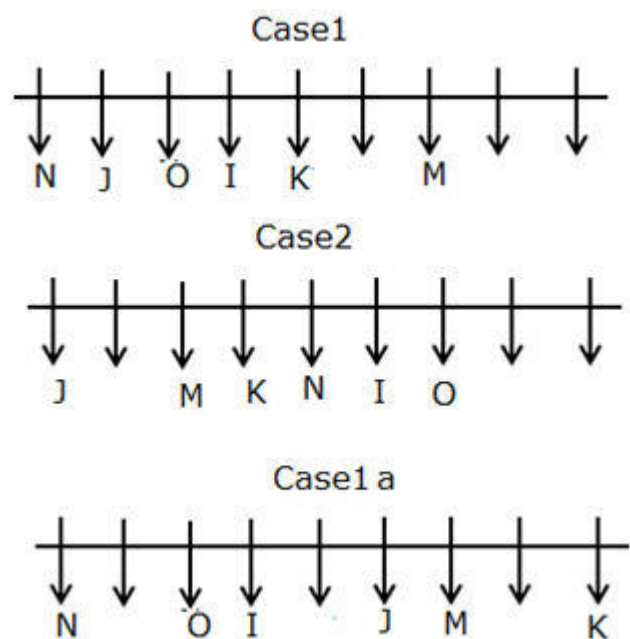

Again we have,

[Click Here For Bundle PDF Course](#)

[Click Here to Subscribe Our Yearly Mock Test Package](#)

Linear Seating Arrangement for Bank Exam – Question Bank Set 2 (Eng)

- As many persons sit between M and Q as between K and P.

From the above condition and note, case2 and case1a get eliminated. Case1 shows the final arrangement.

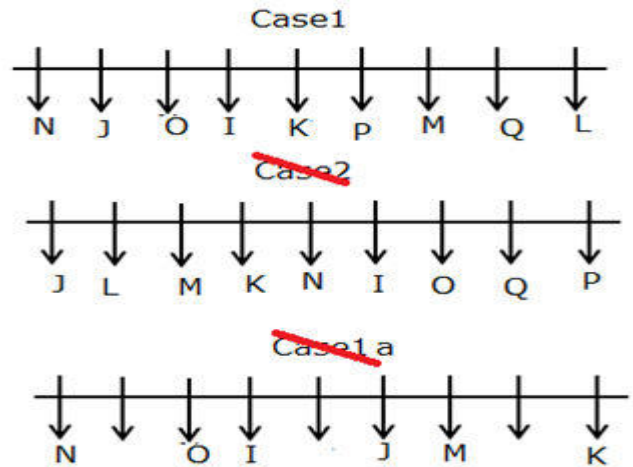

[Click Here For Bank Exam Free PDF](#)

[Click Here For Reasoning Free PDF](#)

[Click Here For Quantitative Aptitude Free PDF](#)

[Click Here For English Free PDF](#)